

DOSSERT®

TYPE 5400 Series

Tee Connector-Closed Run Compression

For Stranded EC and ACSR Conductions

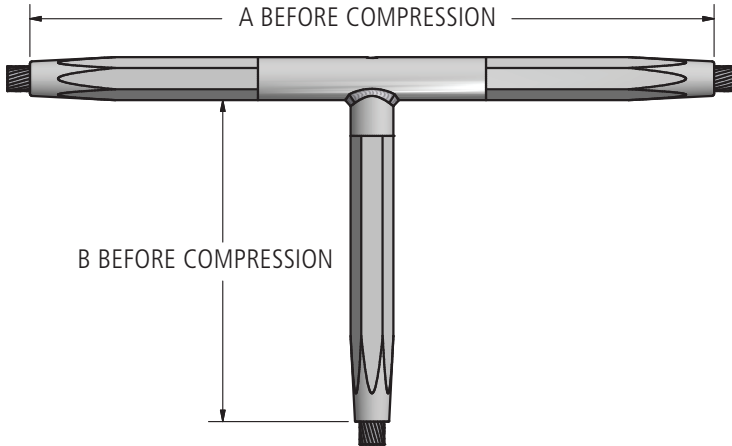

Ordering Information

CATALOG NUMBER	CONDUCTOR					DIE SIZE ALUMINUM HEX DIE	DIMENSIONS IN INCHES	
	ACSR OR AAC	CODE WORD	SIZE KCMIL	STRANDING AL/ST	DIAMETER IN INCHES		A	B
5030.109-30.109	ACSR	Stilt	715.5	24/7	1.036	30AH	19.12	9.44
5030.109-30.109	ACSR	Starling	715.5	26/7	1.051	30AH	19.12	9.44
5030.109-30.109	ACSR	Coot	795	36/1	1.040	30AH	19.12	9.44
5030.109-30.109	AAC	Arbutus	795	37	1.026	30AH	19.12	9.44
5030.109-30.109	AAC	Lilac	795	61	1.028	30AH	19.12	9.44
5030.109-30.109	AAC	—	800	37	1.031	30AH	19.12	9.44
5030.109-30.109	AAC	Heliotrope	800	61	1.031	30AH	19.12	9.44
5030.116-30.116	ACSR	Redwing	715.5	30/19	1.081	30AH	19.12	9.44
5030.116-30.116	ACSR	Tern	795	45/7	1.063	30AH	19.12	9.44
5030.116-30.116	ACSR	Condor	795	54/7	1.093	30AH	19.12	9.44
5030.116-30.116	ACSR	Drake	795	26/7	1.108	30AH	19.12	9.44
5030.116-30.116	ACSR	Cuckoo	795	24/7	1.092	30AH	19.12	9.44
5030.116-30.116	AAC	Snapdragon	900	61	1.094	30AH	19.12	9.44
5030.122-30.122	ACSR	Mallard	795	30/19	1.140	30AH	19.12	9.44
5030.122-30.122	ACSR	Ruddy	900	45/7	1.131	30AH	19.12	9.44
5030.122-30.122	ACSR	Canary	900	54/7	1.162	30AH	19.12	9.44
5030.122-30.122	ACSR	Catbird	954	36/1	1.140	30AH	19.12	9.44
5030.122-30.122	ACSR	Rail	954	45/7	1.165	30AH	19.12	9.44
5030.122-30.122	AAC	Magnolia	954	37	1.124	30AH	19.12	9.44
5030.122-30.122	AAC	Goldenrod	954	61	1.126	30AH	19.12	9.44
5030.122-30.122	AAC	Camellia	1000	61	1.152	30AH	19.12	9.44
5030.122-30.122	AAC	Bluebell	1033.5	37	1.170	30AH	19.12	9.44
5030.122-30.122	AAC	Larkspur	1033.5	61	1.172	30AH	19.12	9.44

DOSSERT®

TYPE 5400 Series

Tee Connector-Closed Run Compression

Ordering Information

CATALOG NUMBER	CONDUCTOR					DIE SIZE ALUMINUM HEX DIE	DIMENSIONS IN INCHES	
	ACSR OR AAC	CODE WORD	SIZE KCMIL	STRANDING AL/ST	DIAMETER IN INCHES		A	B
5030.125-30.125	ACSR	Cardinal	954	54/7	1.196	30AH	19.12	9.44
5030.125-30.125	ACSR	Tanager	1033.5	36/1	1.186	30AH	19.12	9.44
5034.128-34.128	ACSR	Ortolan	1033.5	45/7	1.212	34AH	20.12	10.06
5034.128-34.128	AAC	Marigold	1113	61	1.216	34AH	20.12	10.06
5034.138-34.138	ACSR	Bunting	1192.5	45/7	1.302	34AH	20.12	10.06
5034.138-34.138	ACSR	Finch	1113	54/19	1.293	34AH	20.12	10.06
5036.144-36.144	ACSR	Bittern	1272	45/7	1.345	36AH	21.00	10.62
5036.144-36.144	ACSR	Grackle	1192.5	54/19	1.333	36AH	21.00	10.62
5036.144-36.144	AAC	Columbine	1351	61	1.340	36AH	21.00	10.62
5036.144-36.144	AAC	Carnation	1431	61	1.379	36AH	21.00	10.62
5036.147-36.147	ACSR	Pheasant	1272	54/19	1.382	36AH	21.00	10.62
5036.147-36.147	ACSR	Dipper	1351.5	45/7	1.386	36AH	21.00	10.62
5036.147-36.147	ACSR	—	1500	91	1.412	36AH	21.00	10.62
5036.147-36.147	AAC	Gladiolus	1510.5	61	1.187	36AH	21.00	10.62
5038.156-38.156	ACSR	Plover	1431	54/19	1.465	38AH	21.88	10.62
5038.156-38.156	ACSR	Nuthatch	1510.5	45/7	1.466	38AH	21.88	10.62
5038.156-38.156	AAC	Coreopsis	1590	61	1.250	38AH	21.88	10.62
5038.156-38.156	AAC	Dogwood	1590	91	1.454	38AH	21.88	10.62
5040.162-40.162	ACSR	Parrot	1510.5	54/19	1.506	40AH	22.75	11.75
5040.162-40.162	ACSR	Lapwing	1590	45/7	1.504	40AH	22.75	11.75
5040.162-40.162	ACSR	Falcon	1590	54/19	1.545	40AH	22.75	11.75
5040.162-40.162	AAC	Jessamine	1750	61	1.525	40AH	22.75	11.75
5042.178-42.175	ACSR	Chukar	1780	84/19	1.602	42AH	23.62	12.38
5042.178-42.175	ACSR	—	2034	72/7	1.681	42AH	23.62	12.38
5042.178-42.175	AAC	Cowslip	2000	91	1.630	42AH	23.62	12.38
5044.184-44.184	ACSR	Bluebird	2156	84/19	1.762	44AH	26.75	12.00
5044.188-44.188	ACSR	Thrasher	2312	76/19	1.802	44AH	26.75	12.00
5044.188-44.188	AAC	Lupine	2500	91	1.823	44AH	26.75	12.00