

Trunnion for OPGW

The trunnion support clamp is used to secure the OPGW cable to a trunnion type bracket configuration. Either mounted directly to the tower or an insulator, the clamp provides enough force to maintain the designed slip load without causing cable attenuation. For more information, contact factory regarding slip load capabilities.

Features

- Keeper is designed for easy installation without removal of keeper bolts. Break-away head bolts ensure proper installation torque.
- Clamp assembly includes Armor Rod set.
- Weight: 3.5 lbs. (1.6 kg)
- Line angles up to 20°

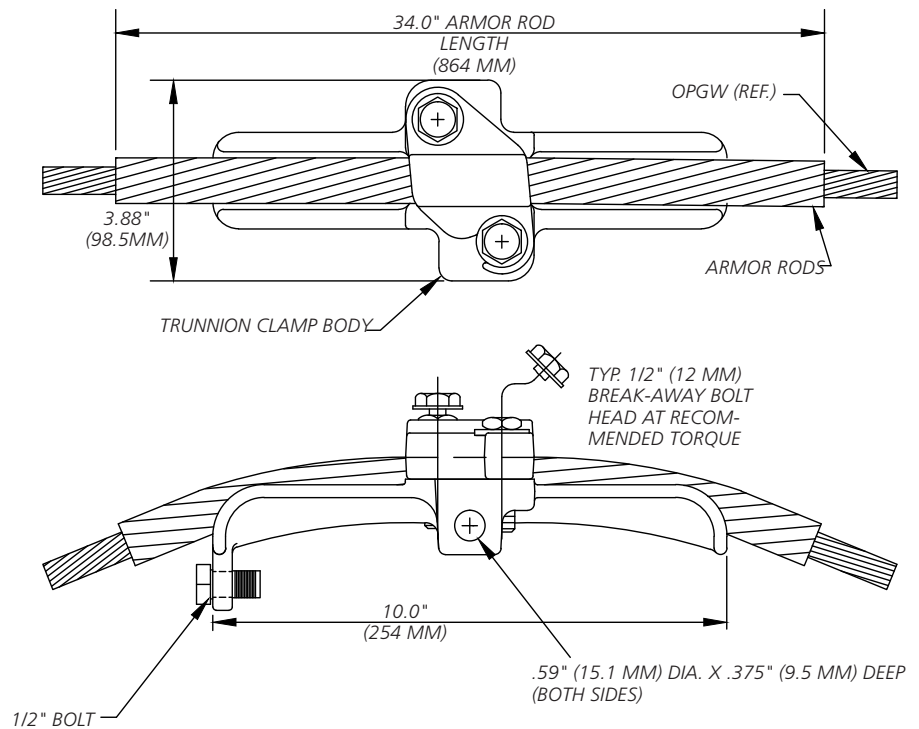

Ordering Information

AFL NO.	OPGW CABLE DIAMETER RANGE	
	INCHES	MILLIMETERS
OTR421/449G	.421 - .449	10.69 - 11.40
OTR450/475G	.450 - .475	11.43 - 12.07
OTR476/499G	.476 - .499	12.09 - 12.67
OTR500/527G	.500 - .527	12.70 - 13.39
OTR528/555G	.528 - .555	13.41 - 14.10
OTR556/584G	.556 - .584	14.12 - 14.83
OTR585/614G	.585 - .614	14.86 - 15.60
OTR615/646G	.615 - .646	15.62 - 16.41
OTR647/679G	.647 - .679	16.43 - 17.25
OTR680/714G	.680 - .714	17.27 - 18.14
OTR715/750G	.715 - .750	18.16 - 19.05

NOTE: For installation instructions, see page 134.